



FANS AND HEATERS



- Axial
- Centrifugal
- In-Line Centrifugal
- Double-Inlet Centrifugal

AXIAL FANS

NOT ALL FANS ARE ALIKE. Sukup® axial fans give the highest airflows and a quality you can count on. Our high performance axial fans are ideal for lower static pressures found in aeration or in-bin drying. All fans and heaters are thoroughly tested prior to shipping. Our fans and heaters are backed with a two-year limited warranty* on components.

BLADES

- Cast aluminum blades produce high airflow efficiently and economically
- 3,500 RPM motors have been specially engineered for Sukup's high-performance blades
- All fan blades are precision-balanced for vibration-free operation
- The large hub on the blade prevents back leakage of air at higher static pressures
- Blades are secured to the motor shaft with Trantorque® bushings to ensure the most secure attachment, as well as serviceability
- Unique square end plates maintain accurate roundness of the housing to allow closer clearance between blade tips and housing
- Square end plates also give uniform support around the housing by eliminating legs that concentrate stress and distort the housing
- Close tip clearance increases airflow by preventing air from blowing back between blade and housing

FEATURES

- Galvanized housings resist rust
- Fans can easily be mounted to push or pull air
- Change wiring easily on the dual-voltage motor, since the connection box is on the end of the motor rather than on one side
- Housings are huck bolted together for more solid, secure assembly; Other companies use common nuts and bolts that can work loose over time
- Plated screen guard bolts over air intake for added safety



Housing bolts



Plated Screen Guard

FAN COMPARISONS

Different types of fans are designed for different operating situations. It is important to match the fan to your system.

The chart below is designed to help in the decision making process by comparing different fan types at various static pressures. Your local Sukup dealer can also help you make the right choice with their knowledge and assistance with the Sukup Airflow and Drying Rates Program.

STATIC PRESSURE - INCHES OF WATER							
FAN TYPE	HP	RPM	0	2	4	6	8
Axial	5-7	3,500	12,800	10,300	6,250		
Centrifugal	7 ½	1,750	12,000	10,400	8,500	6,700	
High-Speed Centrifugal	7 ½	3,500	5,005	4,600	4,250	3,850	3,400
In-Line Centrifugal	5-7	3,500	6,370	5,815	5,150	4,715	3,935

FAN SIZE	HORSEPOWER
12"	¾ or 1 HP
14"	1 ½ HP
18"	2 or 3 HP
24"	5-7 HP
24"	7-10 HP
28"	10-15 HP
38"	15 HP
44"	15 or 30 HP

* Standard terms & conditions of limited warranty & purchase agreements apply.

12", 14" AND 18" AXIAL FAN

- Sukup fans are ideal for applications where static pressure is less than 2"
- Totally Enclosed Fan Cooled (TEFC) motors have been designed for years of trouble-free operation
- 12" and 14" fans come wired with cord
- 18" available with or without controls



24" AND 28" AXIAL FAN

Sukup 24" and 28" fans are designed to partner with a Sukup Heater for grain drying at lower static pressures. They may also be used alone for pressure aeration.

- 3,500 RPM
- Maximum airflow at lower static pressures
- 230 volt single or three phase or 460 volt three phase; 575 or 208 volt available
- Heavy-duty motors for dependable operation
- CSA (Canadian Standards Association) models available
- Available with or without controls; UL listed controls
- Exclusive built-in venturi (air intake) increases airflow



38" AND 44" LOW-SPEED FAN

- 1,750 RPM
- Are ideal for shallow grain depth applications
- High airflow at low static pressure
- Quieter than high speed axials
- Excellent for drying crops such as ear corn, nuts, onions or any other crop dried at shallow grain depths in flat storage facilities



CENTRIFUGAL FANS

- All fans and heaters are factory-tested for smoothness, motor performance and general operation to ensure our customers are getting a top quality product that works properly from day one
- Our engineers test motor amperage and temperature under long-term, maximum-load conditions to ensure that the motors will stand up to tough operating environments
- Integral motor mount
- Direct motor drive for greater efficiency and less maintenance
- Fan housings are heavy-duty galvanized steel to resist rust and stand up to the elements
- Control boxes and motor mounts are also galvanized steel to make high-quality, long-lasting fans
- UL listed controls
- Single inlet fans from 3-100 HP
- Plated screen guard over air intake for safe operation
- Curved spun inlet venturi improves efficiency; Finished with powder-coat paint for ultimate rust prevention

AVAILABLE MODELS:

- Single and three phase, 60 HZ
- Three phase - 50HZ

CONTROLS INCLUDE:

- Magnetic starter
- Branch circuit protection
- Start-stop buttons
- 115 volt circuit to interlock heater with fan (7.5 - 50 HP RPM)
- Adjustable leveling legs on single inlet fans allow easy leveling and support to accommodate inconsistencies in concrete
- Exclusive lip easily connects the fan to the heater or transition to form an airtight seal
- Special airfoil blades move more air due to a backward-curved, non-overloading design
- Fan wheels are dynamically balanced for smooth, trouble-free operation

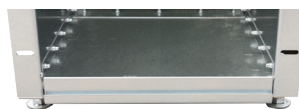

DOUBLE INLET

- 30-50 HP 1,750 RPM Double Inlet Fans
- Double-blade design is more efficient and gives more airflow than comparable single blade fans
- Double air inlet pulls air over the motor, utilizing motor heat
- Engine-driven fans are also available



HIGH SPEED

- Sukup also offers a full line of high speed 3,500 RPM centrifugal fans
- Ideal for deep grain depths, aerating small grains or where static pressure is high
- TEFC motors
- CSA models available in sizes 3-50 HP



OPTIONS

- CSA models available
 - 3-20 HP, 1,750 RPM
 - 3-50 HP, 3,500 RPM
- TEFC motors
- Cable hanging kit supports fan and motor
- Counter-balanced fan shutters recommended for multiple fan installations



Fan Shutter

AIRFLOW

CERTIFIED AIRFLOW* FOR 1,750 RPM CENTRIFUGAL FANS -CFM

STATIC PRESSURE - INCHES OF WATER											
HP	0	1	2	3	4	5	6	7	8	9	10
3	5,300	4,500	3,800	3,400	3,000	2,600					
5*	9,500	8,900	7,650	6,700	6,000	5,000					
7 1/2**	12,000	11,300	10,400	9,400	8,500	7,700	6,700				
10*	16,000	15,150	14,200	13,200	12,200	11,200	10,100	7,800	3,300		
15*	18,000	17,000	16,100	15,200	14,300	12,700	11,700	11,100	8,700		
20*	23,600	22,800	21,750	20,650	19,600	18,500	17,200	15,800	14,500	12,000	
30 SNG.	24,701	23,787	22,873	21,958	21,044	20,143	19,251	18,359	17,383	16,403	12,100
30 DBL.	34,000	32,200	30,300	28,600	27,000	25,500	23,500	21,800	19,500	16,700	13,700
40 DBL.	43,400	41,400	39,300	37,300	34,600	31,800	29,100	27,200	25,000	22,200	19,000
50 DBL.	54,000	50,800	47,400	44,000	40,600	37,400	34,000	30,800	28,600	25,800	20,500

*Sukup Manufacturing Co. certifies that the airflow for designated fan models has been determined by an INDEPENDENT airflow testing laboratory.

AIRFLOW FOR 1,750 RPM CENTRIFUGAL FANS -CFM

STATIC PRESSURE - INCHES OF WATER											
HP	0	2	4	6	8	10	12	14	16	18	20
40	31,300	29,900	28,000	25,700	23,300	20,700					
50	32,300	30,640	28,975	27,310	25,410	23,275	20,425				
60	26,800	24,500	23,000	21,500	20,300	19,000	29,000	26,500	23,500	19,300	
75	35,000	32,500	30,750	28,750	26,500	24,250	22,000	20,000	17,250	12,250	
100	45,500	42,000	39,000	36,000	33,000	31,000	29,000	26,500	23,500	19,300	

AIRFLOWS FOR 3,500 RPM CENTRIFUGAL FANS - CFM

STATIC PRESSURE - INCHES OF WATER												
HP	0	2	4	6	8	10	12	14	16	18	20	22
3	3,300	2,800	2,400	1,950	1,350	900						
5	4,450	4,050	3,550	3,000	2,350	1,550						
7 1/2	5,050	4,600	4,250	3,850	3,400	2,900	2,350	1,650				
10	7,300	6,850	6,350	5,800	5,400	4,700	3,950	2,400				
15	10,050	9,500	8,850	8,050	7,350	6,350	4,750	2,650				
20	10,800	10,350	9,850	9,300	8,700	8,150	7,550	6,850	6,150	5,200	4,100	
30	14,500	13,800	13,000	12,300	11,600	10,800	10,200	9,400	8,400	7,800	6,800	
40	19,000	18,300	17,200	16,200	15,300	14,300	13,100	11,700	9,500	9,000	7,800	
50	22,400	21,200	20,100	19,300	18,500	17,750	16,500	15,050	14,175	12,950	11,500	
60	24,000	23,300	22,600	21,500	20,800	19,500	18,800	17,750	17,000	16,000	15,400	14,500

IN-LINE CENTRIFUGAL FANS

- Ideal for almost any high static pressure application, such as aerating small grains, aerating tall bins, or cooling grain in roof dryer bins
- Provides excellent airflow beyond the range of a standard axial, without the noise of an axial fan
- Unique square end plates maintain the accurate roundness of the housing, give uniform support all around and eliminate the need for extra legs that concentrate stress and distort the housing
- Curved venturi makes airflow into the blade more efficient
- Heavy-gauge, galvanized housings resist rust and ensure long life
- Costs less than a standard centrifugal fan, so they're practical, as well as efficient
- More compact than standard centrifugal fans; Compact design makes them ideal for aerating hopper bottom tanks
- Sealed control box with start/stop buttons, magnetic starters, and overload is standard on fans 4.5 HP or larger
- Precision-balanced blades ensure smooth operation



- 3500 RPM motor is specially-engineered for high-performance blades to ensure maximum airflow and long life; single or three phase available
- CSA units available

AIRFLOW FOR IN-LINE CENTRIFUGAL FANS - CFM

STATIC PRESSURE - INCHES OF WATER										
DIA.	HP	0	1	2	3	4	5	6	7	8
18"	4.5	4,450	3,970	3,480	3,060	2,630	1,890	1,075		
24"	5-7	6,370	6,100	5,815	5,480	5,150	4,935	4,715	4,375	3,935
24"	7-10	7,645	7,240	6,830	6,540	6,245	5,835	5,440	5,170	4,470
28"	10-15	9,440	8,850	8,320	7,850	7,450	7,110	6,810	6,540	6,260

3,500 RPM IN-LINE CENTRIFUGAL FAN DIMENSIONS - INCHES

DIA.	HP	A	B	C	D	E	F	G	H	I	J	K	L	M	N
18"	4.5	11	45	36	34 1/8	28 7/16	28 3/8	31 11/16	28 3/8	18 3/16	23 3/4	19 1/2	9 3/4	24	14
24"	5-10	11	45	38	34 1/8	28 7/16	28 3/8	31 11/16	28 3/8	24	24	28 1/2	16 3/4	37 3/4	17
28"	10-15	11	45	38	31 1/2	28 7/16	28 3/8	31 11/16	28 3/8	28 3/16	27	31 1/2	18 1/2	41	18 1/2

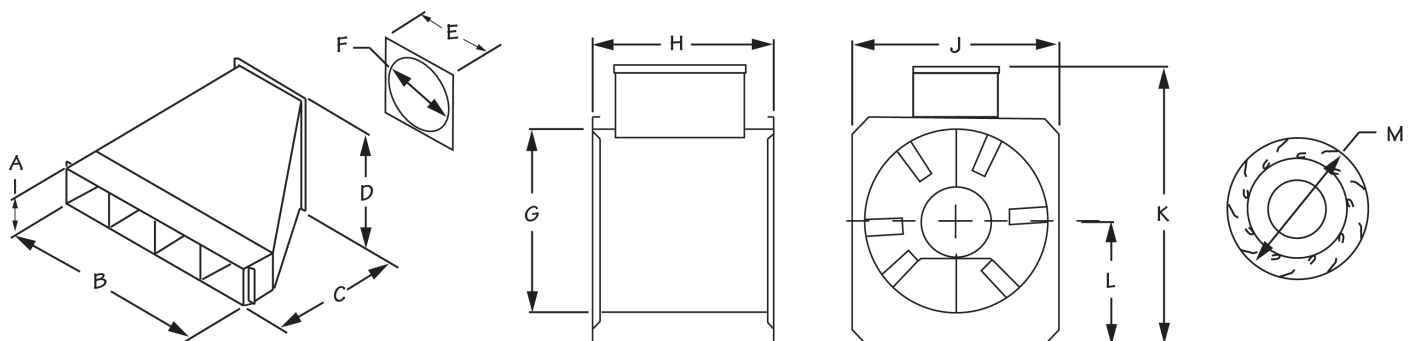

HOPPER AERATION

- 3, 5, 7.5, 10 and 15 HP centrifugal fans
- 18" and 24" in-line centrifugal fans
- 12" - 24" axial fans
- Triangle aeration duct is designed for aeration of hopper bins
- Helps prevent grain spoilage in hopper bins
- Runs are designed to fit between cone panel seams
- Framing made from 8 gauge material
- Desired CFM/BU can be achieved with multiple runs

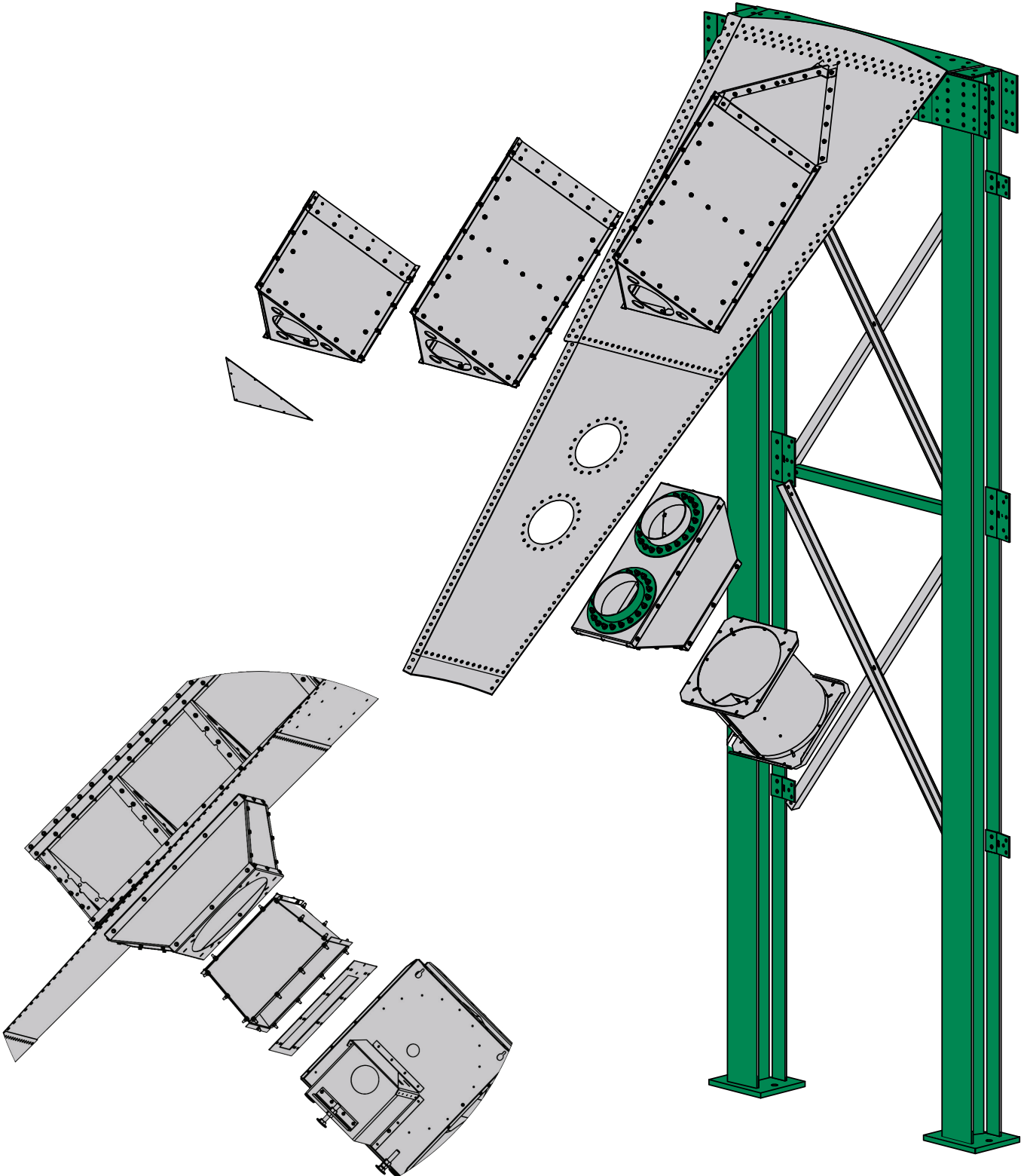

AXIAL AND CENTRIFUGAL HEATERS

STANDARD FEATURES

- Heaters ignite quickly, even at low gas pressures
- Three-year warranty on the solid state circuit board
- Thermostat, humidistat, high-low thermostat or modulating valve available
- Air straightening vanes provide better heat distribution
- Galvanized housings resist rust
- CSA models available
- Starfire-type burner on axial heaters provides critical gas and air mixture for high efficiency and even heat distribution
- Sukup Stainless Steel Flame Sensor is more reliable and lasts longer than flame probe

OPTIONAL FEATURES

- Differential Controller limits plenum temperature to within 10° of ambient; For super-low temp heaters
- Deluxe Control Box includes a static pressure gauge and thermometer; Available as single or dual controls
- Dual Burner Controls are needed if there is more than one heater on a bin, so they cycle on and off together for even heat

SAFETY FEATURES

- Heaters have more standard safety features than others increasing reliability
- Pressure relief valves on piping
- 30-second purge delay to clear air
- Stainless steel flame sensor shuts off gas if flame is not present
- Spring-loaded solenoids automatically close when electricity shuts off
- Electrical components are grounded
- Standard divided control box separates gas and electrical components while protecting them from the elements
- Transition high limit shuts off heater if air entering bin is too hot
- Vapor high limit
- Burner high limit

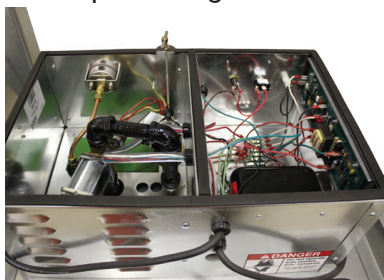

EASY ACCESS SERVICE DOOR

- Sukup heater housings have a large service door to allow easy access to all heater components
- A sight glass in the top of the housing allows for easy inspection while burning

LOW-TEMP HEATER

- Sukup manufactures special downstream, low-temp heaters which operate on propane, rather than electricity
- For equal cost, propane gives up to 70% more heat than electricity
- Temperature rise of 25-75°
- More flexibility than an electric heater

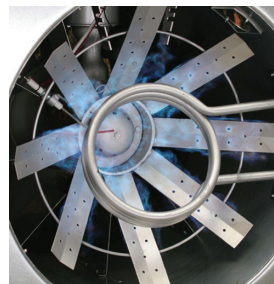

Star-fire Burner

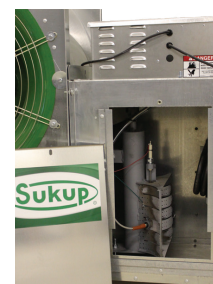

Service Door

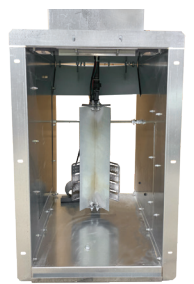

Low-Temp Heater

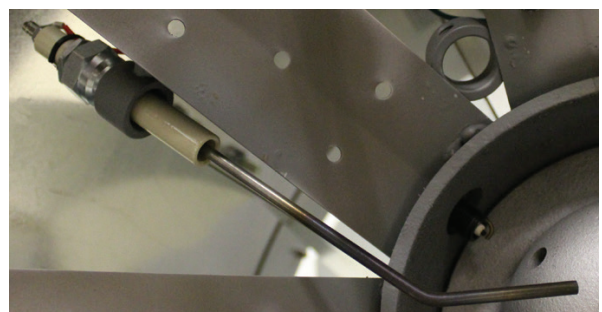

Stainless steel flame sensor

HIGHLY EFFICIENT BURNING

- Extensive testing results in centrifugal heaters that allows complete combustion at up to 6" of static pressure
- Independent tests have shown Sukup heaters burn within the highest efficiency range
- Coiled vaporizer is available to burn liquid propane where more heat is required, as in colder climates
- Two-way adjustment on vaporizer allows operation over a wider range of outside temperatures
- Exclusive Sukup vaporizer high limit features manual reset, so you can tell if vaporizer needs to be adjusted



Sukup Vaporizer

FUEL TYPES

- Liquid propane
- Vapor propane
- Natural Gas - regulator not included -- 3/4" or 1 1/4" pipe size
- CSA and CE models available

HEATER PLACEMENT

Placing the heater downstream, between fan and transition, air goes through the fan and then is heated. Because air expands as it is heated, this design gives up to 20% greater drying capacity than an upstream heater placed on the fan inlet.

HEATER MAX BTU/HR

HEATER MODEL	TEMP RISE	CENTRIFUGAL FAN			AXIAL HP		
		7.5-15	20	30-50	18"	24"	28"
Hi-Temp	50-180°F	2.7M	3.7M	5.4M	1.4	2.0	2.7
Lo-Temp	25-75°F	.72M	.72M	1.44M	.42	.72	1.4
Super Lo-Temp	10-30°F	.3M	.5M	1M	.3	.50	1.0

RELIABLE CONTROLS

- Sukup heaters feature a special solid state circuit board for simpler, more trouble-free operation
- Benefits of Sukup solid state controls include:
 - Sukup stainless steel flame sensor is more reliable and will last longer than flame probes
 - Unique, separate transformer produces an aggressive spark for reliable, easy ignition
 - Solid state circuitry allows additional safety features for greater reliability

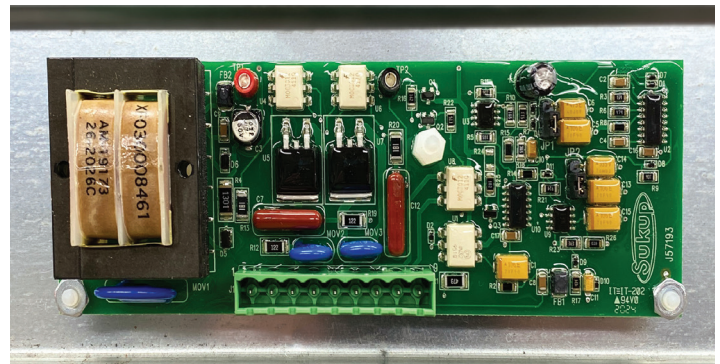

HEATER CONTROL OPTIONS

- **Thermostat** cycles burner off and on; Not recommended for high temp systems since cool air is blown into bin when burner cycles off
- **Modulating valve** automatically adjusts gas pressure to maintain constant drying temperature under the floor
- **High-Low continuous flame** cycles between higher and lower gas pressures for more uniform temperature with greater reliability; Not for low temperature systems
- **Dual burner controls** with optional gauges control multiple heaters from one control box to ensure they cycle on and off together for even heat
- **Deluxe control box** includes a static pressure gauge, thermometer, and temperature controller



SPECIFICATIONS

Each type of fans is designed for a specific operating situation. It is important to match the fan to your system. Our specification charts are designed to help in the decision making process by comparing different fan and heater types at various static pressures.

AIRFLOWS FOR AERATION APPLICATIONS - 3,500 RPM - CFM

MODEL		STATIC PRESSURE - INCHES OF WATER										
DIA.	HP	0	0.5	1	1.5	2	2.5	3	3.5	4	4.5	5
12"	¾ HP	1,900	1,675	1,290	815	550	325	100				
12"	1 HP	2,308	1,963	1,460	876	595	305					
14"	1½ HP	3,132	2,852	2,526	2,126	1,511	1,040	720				
18"	1½-2 HP	5,450	4,850	4,250	3,600	2,800	2,000	1,500	1,050			
18"	3 HP	7,000	6,600	6,150	5,575	4,850	3,950	3,100	2,400	1,900	1,700	1,300

CERTIFIED AIRFLOW* FOR AXIAL FANS - 3,500 RPM - CFM

MODEL		STATIC PRESSURE - INCHES OF WATER								
DIA.	HP	0	1	2	3	4	5	6	7	8
24"	5-7 HP	12,800	11,750	10,300	8,600	6,250	3,350	1,900	600	
24"	7-10 HP	15,200	13,750	12,250	10,500	7,600	3,900	2,100	400	
28"	10-15 HP	19,050	17,300	15,600	13,600	11,100	7,350	4,800	2,800	700

**Sukup Manufacturing Co. certifies that the airflow for the fan models above has been determined by an INDEPENDENT airflow testing laboratory.*

AIRFLOWS FOR LOW SPEED AXIAL FANS - 1,750 RPM - CFM

MODEL		STATIC PRESSURE - INCHES OF WATER							
DIA.	HP	0	0.5	1	1.5	2	2.5	3	3.5
38"	15 HP	28,000	26,000	24,000	22,300	21,800	19,000	16,500	13,500
44"	15 HP	42,000	40,000	36,000	32,000	27,500	22,300	14,300	
44"	30 HP	46,000	43,900	41,400	38,800	36,300	33,600	30,600	27,000

AXIAL FAN AND HEATER DIMENSIONS - INCHES

DIA.	A	B	C	D	I	J	K	L	M	N	O	P	Q	R	S	T	U	V	W		
12"	11	45	36	34 1/8			14 1/2	14 1/8		12 1/8		7	14 1/2	14 1/2	14 3/4	14 1/2	16 1/8	12 1/8	14 1/8		
14"	11	45	36	34 1/8			16 1/2	16 1/8		16 3/16		8	16 1/2	16 1/2	16 7/8	16 1/2	16 1/8	16 3/16	16 1/8		
18"	11	45	36	34 1/8	19 5/8	10	17 7/8	19 7/8	24 1/4	18 3/16	28 1/2	10	19 7/8	17 7/8	24 1/2	19 1/2	18 1/4	18 3/16	19 7/8		
24"	11	45	36	34 1/8	26	16 1/2	27 5/8	30 1/8	34 1/4	24 1/4	38	16 1/2	30	27 5/8	38	31 1/2	26 1/2	24 3/16	30 1/8		
26"					27 1/4	14 1/4		28 1/2	24 1/4	26 1/4	36							26 1/4	28 1/2		
28"	11	45	36	34 1/8	29 3/4	18 1/4	31 5/8	34 1/8	24 1/4	28 5/16	41 1/2	18 1/4	33 5/8	31 5/8	42	35 1/16	26 7/8	28 5/16	34 1/8		
38"							23 5/8	45	30	38 3/8	52	23 5/8	42 1/2		52			28 1/2	38 3/8	45	
44"							28 3/4		53	30	44 3/8	60	28 3/4	48 1/2		60			29 1/4	44 3/8	53

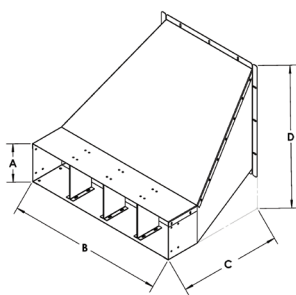

Transition

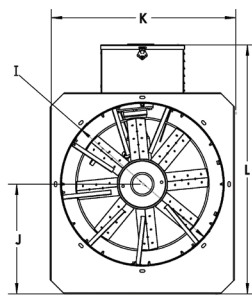

Heater

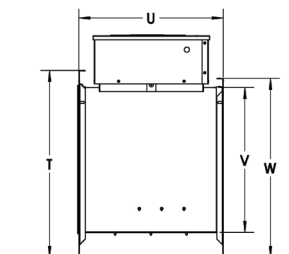
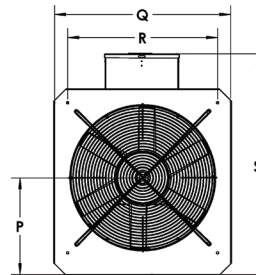
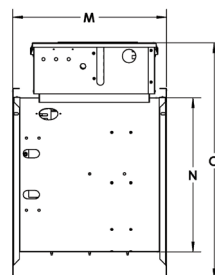

Fan

1,750 RPM CENTRIFUGAL FAN DIMENSIONS - INCHES

HP	A	B	C	D	I	J	K	L	M	N	P	Q	R	S	T
3	11	45	36	40							24 3/4	19 3/4	16 1/8	12	29 1/2
5	11	45	36	40							30 3/8	27 1/8	20	15 5/8	32 1/2
7 1/2	11	45	36	40	28 15/16	33 1/16	22 5/8	18 7/16	24 1/8	39	32 5/8	29 1/8	22 1/8	18	38 1/2
10	11	45	36	40	28 15/16	33 1/16	22 5/8	18 7/16	24 1/8	39	23 5/8	29 1/8	22 3/8	18 1/4	39 1/2
15	11	45	36	40	28 15/16	33 1/16	22 5/8	18 7/16	24 1/8	39	32 5/8	29 1/8	23 1/2	19 3/20	42 1/4
20	11	45	36	40	38 1/8	34 1/8	24 3/8	20 3/8	24 1/8	44 5/16	37 3/4	34 3/4	24 1/4	20	43
30 sng.	11	45	36	40	38 1/8	34 1/8	24 3/8	20 3/8	24 1/8	44 5/16	37 3/4	34 3/4	28 1/8	24	48
30 dbl.	14 3/16	100	48	38 15/16	38 1/8	34 1/16	46 3/8	42 3/16	24 1/8	44 1/8	37 3/4	34 1/8	46 1/8	42	80
40 sng.	11	45	36	40							37 3/4	34 1/2	30 1/16	25 7/8	55 13/16
40 dbl.	14 3/16	100	48	38 15/16	38 1/8	34 1/16	46 3/8	42 3/16	24 1/8	44 1/8	37 3/4	34 1/8	46 1/8	42	80
50 sng.											42 1/4	38 3/4	26 1/16	22 9/16	52 3/4
50 dbl.	14 3/16	100	48	38 15/16	38 1/8	34 1/16	46 3/8	42 3/16	24 1/8	44 1/8	37 3/4	34 1/8	48 3/8	44	84

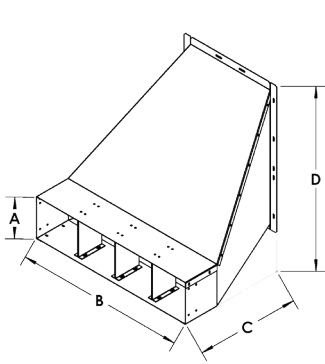

Transition

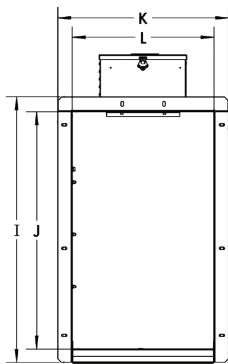

Heater

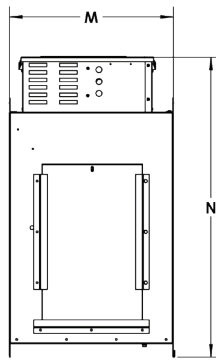

Fan

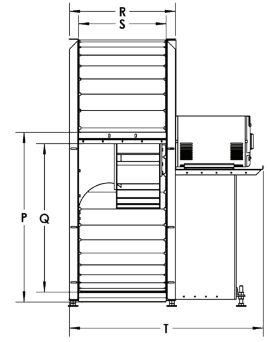
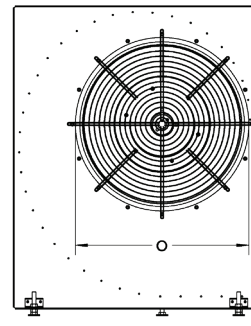

3,500 RPM CENTRIFUGAL FAN DIMENSIONS - INCHES

HP	A	B	C	D	P	Q	R	S	T
3	11	45	36	40	19 3/8	16 3/4	11 1/4	7 3/8	26 1/2
5	11	45	36	40	19 3/8	16 3/4	13 1/8	9	28
7 1/2	11	45	36	40	22 1/2	19	13 1/2	9 3/8	30
10	11	45	36	40	22 1/2	19	15 1/2	11 1/4	32
15	11	45	36	40	22 1/2	19	16 3/8	12 3/8	33
20	11	45	33	40	24 3/4	20 7/8	15 3/8	11 3/8	36 3/8
30	11	45	36	40	24 3/4	20 7/8	18 5/8	13 3/4	43 1/2
40	11	45	36	40	30 3/8	27 1/8	20	15 5/8	45 1/4
50	11	45	36	40	32 5/8	29 1/8	20	15 5/8	45 1/2
60	11	45	36	40	33	29 1/8	20 1/4	16 1/8	47 3/8

Sukup Manufacturing Co. provides this information to assist you in choosing the optimal equipment for your situation. Sukup specifications should only be used as estimates, and not as a warranty, express or implied, of how a particular Sukup unit will perform under your operating conditions. Because we are continuously improving Sukup products, changes may occur that may not be reflected in the specifications.

DRYING, STORAGE and HANDLING SOLUTIONS®



We've spent more than 55 years developing innovative, efficient, and reliable products to meet the ever-expanding needs of grain producers. With a full-line of product Solutions®, Sukup has all your grain handling, storage, drying, and steel building needs.

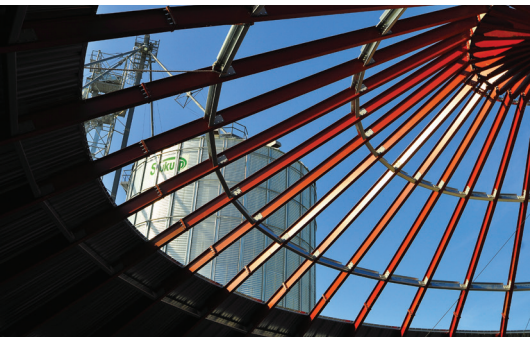

Sukup Manufacturing Co. ■ www.sukup.com

Box 677 ■ 1555 255th Street ■ Sheffield, Iowa 50475-0677 ■ ph 641.892.4222 ■ fx 641.892.4629 ■ info@sukup.com

Distribution Centers

Cameron, MO 64429 7426 NE 352 nd St. ph 816.649.2226 missouri@sukup.com	Arcola, IL 61910 980 E. State Rte. 133 ph 217.268.3026 illinois@sukup.com	Aurora, NE 68818 1705 Hwy. 34 E. ph 402.694.5922 nebraska@sukup.com	Defiance, OH 43512 7724 Rte. 66 N. ph 419.784.9871 ohio@sukup.com	Jonesboro, AR 72403 204 Best Industrial Dr. ph 870.932.7547 arkansas@sukup.com	Watertown, SD 57201 2701 Piper Ave. ph 605.882.6697 southdakota@sukup.com
---	--	--	--	---	---